

Article number: 2301170327
 Description: E+G Handwheel
 VDT.100+IR A-10

Measures

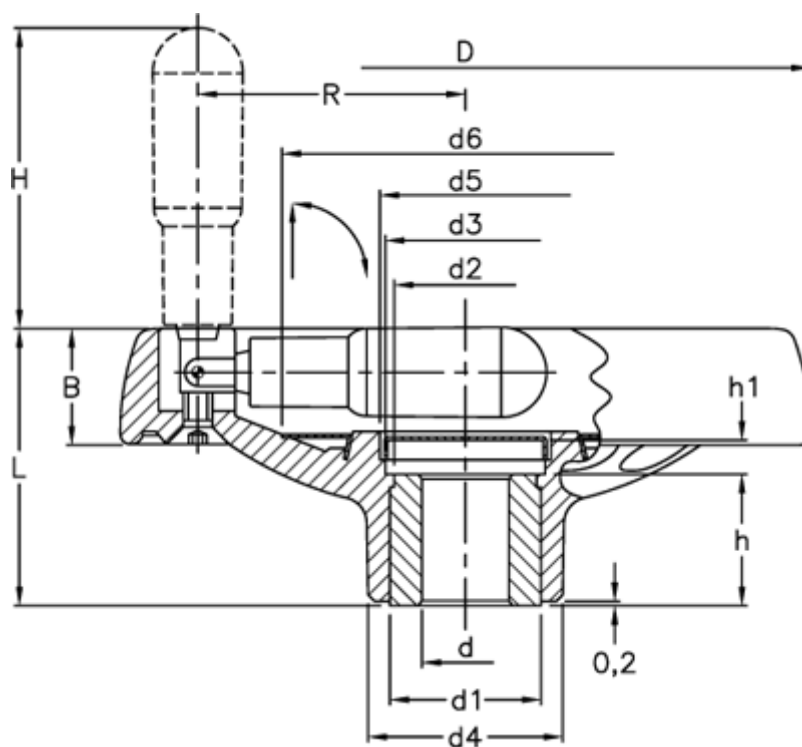

B	= 22	d6	= 54
C (N m)	= 180	d H7	= 10
D	= 100	H	= 60
d1	= 22	h	= 22
d2	= 20	h1	= 5.5
d3	= 26	L	= 49
d4	= 32	L (J)	= 21
d5	= 28	R	= 37